

THE PROPERTY OF THE DRAWING IS ESTABLISHED BY LAW. IT IS FORBIDDEN TO PRODUCE OR SHOW IT TO THIRD PART. WITHOUT A WRITTEN AGREEMENT.

Item	Name	Q.ty
1	CA.08.03.006	1
2	CA.08.09.004	1

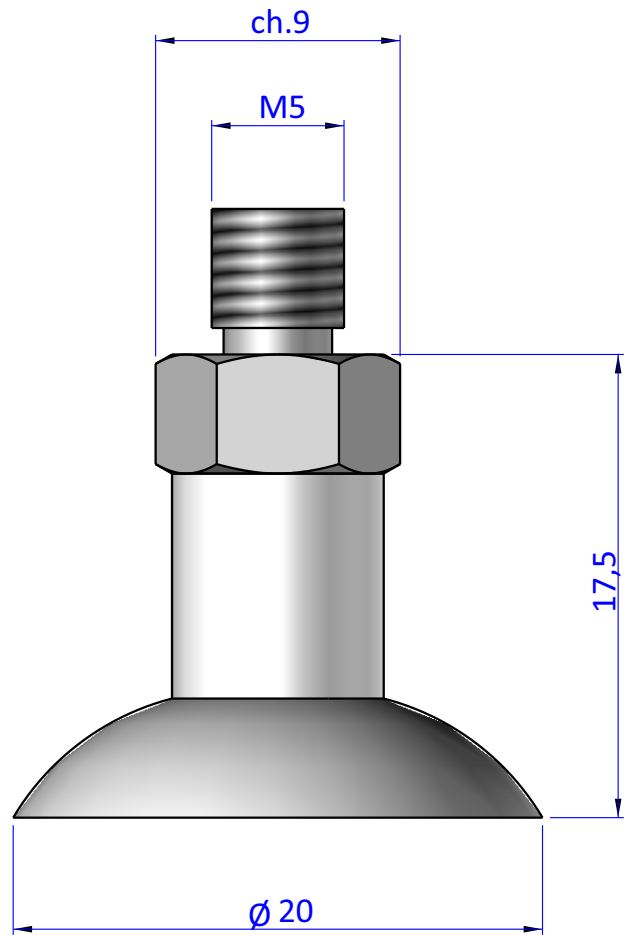
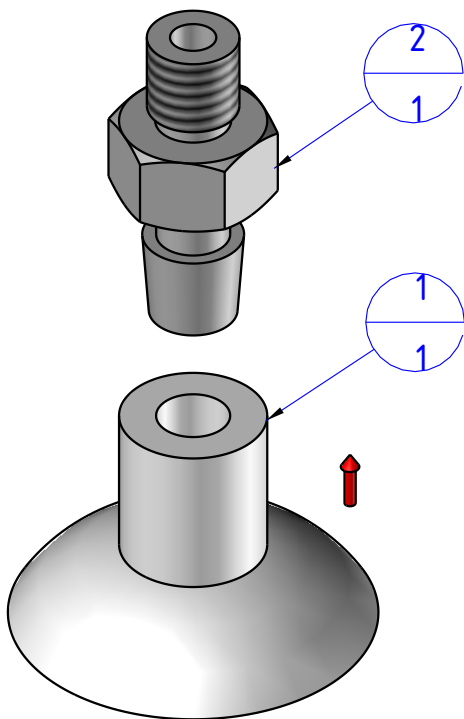

DESIGNED FROM	REVIEW
FPS Automation	A

DATE	WEIGHT
04/11/2020	0,002kg

CODE
KIT.08.03.D20.4

Format A4

UNI 936-76

GENERAL TOLERANCE

UNI - ISO 2768

CLASSE f

DESCRIPTION

KIT.08.03.D20.4